





Инструкция по установке **Mitsubishi Pajero IV** (2007-2020)

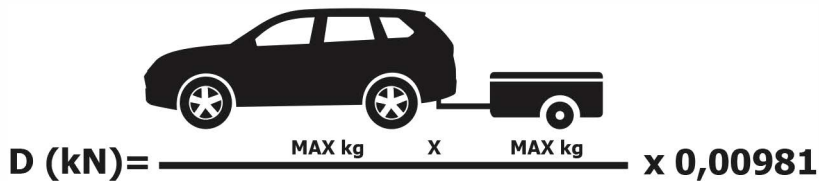

Арт.: F.4011.001

 <p>2000 kg</p>	 <p>75 kg</p>	 $D \text{ (kN)} = \frac{\text{MAX kg} \times \text{MAX kg}}{ + \text{MAX kg}} \times 0,00981$
<p>D = 11,8 kN</p>		

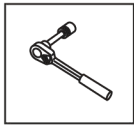

Вкрутить/выкрутить используя инструмент

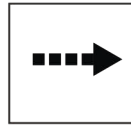

Движение

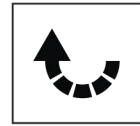

Поворот



Вкрутить/выкрутить не затягивая

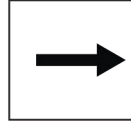

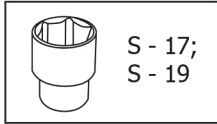
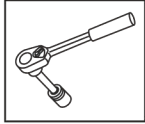

Расположение

Используемый инструмент:

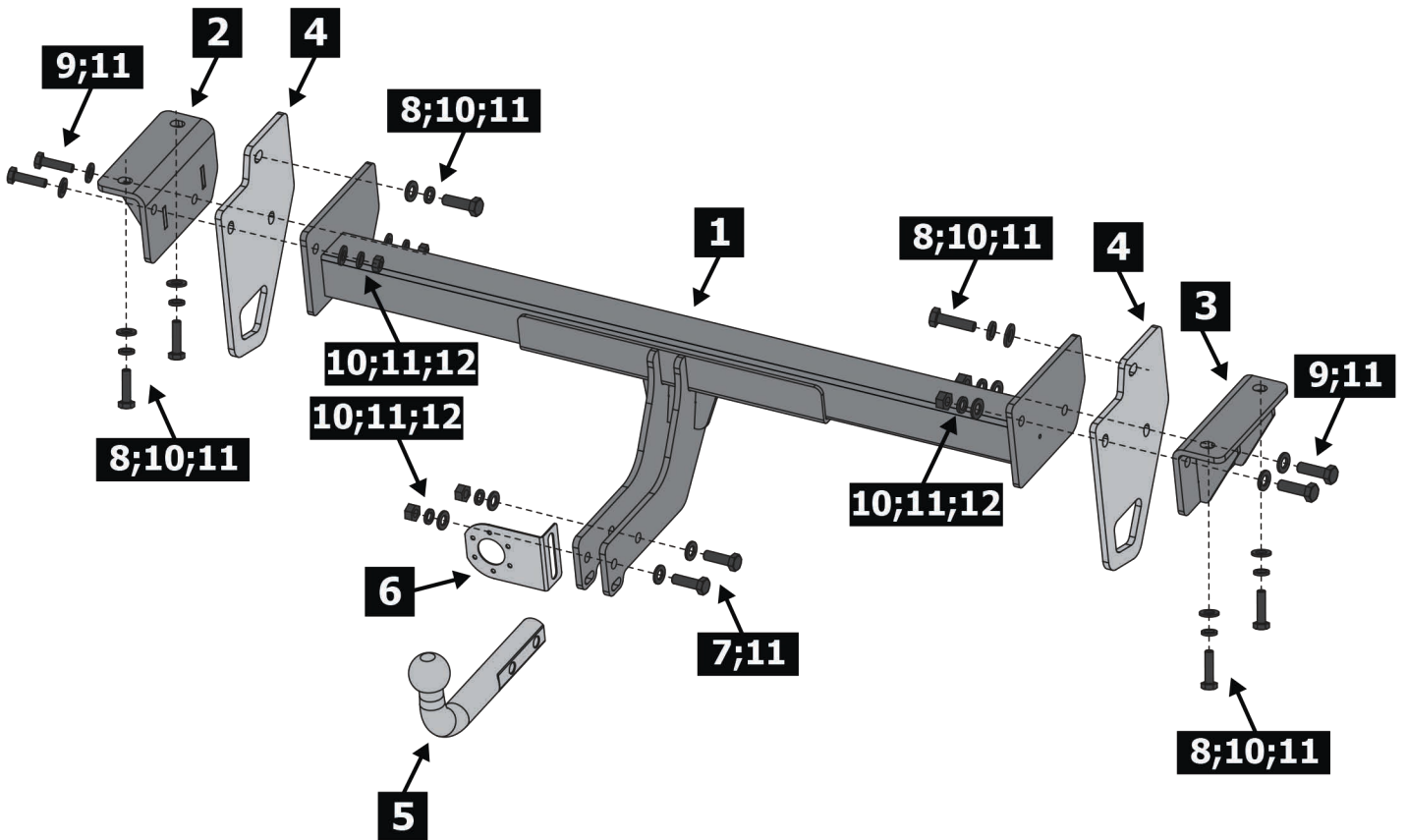

S - 17;
S - 19

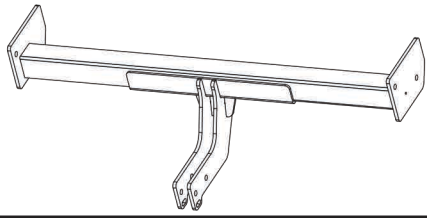
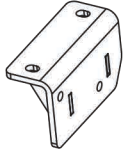
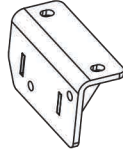
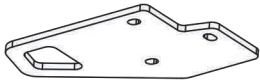
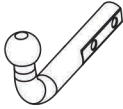
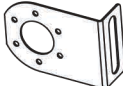
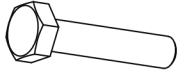
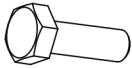
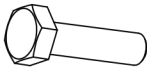

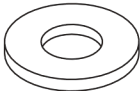
1	x1	Балка	
2	x1	Кронштейн левый	
3	x1	Кронштейн правый	
4	x1	Кронштейн балки	
5	x1	Крюк	
6	x1	Подрозетник	
7	x2	M12x1,25x70	
8	x6	M12x1,25x35	
9	x4	M12x1,25x45	
10	x12	∅ 12	
11	x18	∅ 12	
12	x6	M12x1,25	