



ПРОФЕССИОНАЛЬНЫЕ
АВТОКОМПОНЕНТЫ



100% контроль качества

Мы создали многоуровневую систему контроля качества, которая исключает брак полностью



**Каталог крестовин
TRIALLI 01 (02) 2020**



2

CROCIERA CARDANICA крестовина - u-joint



Крестовина кардана — это шарнир неравных угловых скоростей. Карданная передача с шарниром неравных угловых скоростей применяется на заднеприводных автомобилях и автомобилях с полным приводом для передачи крутящего момента от силового агрегата на колеса автомобиля и позволяет изменять угол вращения под небольшими углами (в пределах пяти градусов). Особенностью шарнира неравных угловых скоростей является неравномерная (циклическая) передача крутящего момента, т.е. за один оборот ведомый вал дважды отстает и дважды обгоняет ведущий вал. Для компенсации неравномерности вращения в карданной передаче применяется не менее двух шарниров, по одному с каждой стороны карданного вала. При этом вилки противоположных шарниров располагаются в одной плоскости.

Внимание! При замене крестовины карданного вала необходимо осмотреть состояние резиновой муфты (не допустимы трещины или механические повреждения, отслоение резины от стальных вкладышей), промежуточной опоры (не допустимы трещины, разрыв эластичной обоймы, подшипник промежуточной опоры должен плавно вращаться). При необходимости заменить дефектные детали!

Внимание! В крестовинах Trialli поступающих в продажу с производства заложена транспортировочная смазка, при установке необходимо заменить смазку!

В крестовинах карданных валов допускается использование пластичной смазки на литиевой основе с допуском NLGI 2 или NLGI LB (для тяжелых условий).



НОВИНКИ / NEW ITEMS / NUOVI PRODOTTI

Марка/ Модель	Характеристики*	Артикул	Страница
BMW 5 F10/F18	D 24mm H 56mm	CC 471	18
TOYOTA RAV4 A30	D 20.92mm H 52.5mm	CC 555	26
GAZ 53 PAZ3205	D 35mm H 98mm	CC 652	31
GAZ 3307/53	D 35mm H 98mm	CC 654	32
GAZON NEXT PAZ Vector Next	D 35.05mm H 106.5mm	CC 656	33
KAMAZ 5490	D 59mm H 167.5mm	CC 622	41
KAMAZ 5490 VOLVO FH/FM	D 65mm H 172mm	CC 732	41

* размеры являются установочными (в свободном состоянии могут отличаться)



Марка	Модель	Характеристики	Номер в каталоге автопроизводителя	Артикул Trialli
NISSAN	Almera N16 (00-)	D 15 mm H 40 mm	NISSAN: 48810-BN008	CC 901 
BMW	3 E36 (90-) 5 E34 (88-)		BMW: 32 31 1 092 958 32 31 1 150 489	
MITSUBISHI	Pajero II (90-) Pajero III (00-)			
MERCEDES-BENZ	Vito (W638) (96-)			

LADA	2106 2105 2107	D 16 mm H 39 mm	LADA: 2105-3401104	CC 905 
UAZ	3151		UAZ: 469-3401153	
OPEL	Vectra C (02-)			







6

CROCIERA CARDANICA
крестовина - u-joint

Марка	Модель	Характеристики	Номер в каталоге автопроизводителя	Артикул Trialli
TOYOTA	RAV 4 (96-) Camry/Vista (90-) Carina ED (89-) Celica (90-) Corolla (82-) Crown (99-08) Estima (93-) Mark2 (96-)	D 15.07 mm H 39 mm	TOYOTA: 54209-32010	CC 912 
NISSAN	X-Trail T30 (01-)			
LAND ROVER	Discovery III (04-)			
TOYOTA	Camry (96-)	D 16 mm H 40 mm	TOYOTA: 45210-32151	CC 910 
LEXUS	RX I (97-)			



Марка	Модель	Характеристики	Номер в каталоге автопроизводителя		Артикул Trialli					
GAZ	3302	D 19 mm H 44.6 mm	GAZ:	3110-3401481	CC 902 					
	2217									
	2705									
	3310									
	3309									
	3308									
	3306									
	4301									
										
	KAMAZ					4308	D 28 mm H ₁ 37 mm H 67.8 mm	KAMAZ:	5320-3422039	CC 906 
4310										
4326										
4350										
5320										
5350										
5410										
5511										
6350										
6520										
6522										
6540										
5321										
5411										
6511										
 										



8

CROCIERA CARDANICA
крестовина - u-joint

Марка	Модель	Характеристики	Номер в каталоге автопроизводителя	Артикул Trialli
URAL	5557 5323 6370 3555 4420	D 28 mm H ₁ 42.5 mm H 73 mm	URAL: 400-2201025	CC 907 
MAZ	504 509 516 53055 5309 5316 5337 5340 5440	 	MAZ: 408-2201025	
MAZ	105 103 104 107 152	D 19 mm H 56.3 mm	MAZ: 104-3444026 6430-3444063	CC 908 
				

CROCIERA CARDANICA
крестовина - u-joint

9



Марка	Модель	Характеристики	Номер в каталоге автопроизводителя		Артикул Trialli
-------	--------	----------------	------------------------------------	--	-----------------

VOLVO TRUCKS

FH 12 (93-)
FH 16 (93-)

D 19.08 mm
H 48 mm

VOLVO:

7035955231

CC 914



TOYOTA:

37420-60040
37602-60200

LADA

2101-2107

D 23.84 mm
H 61.24 mm

LADA:

21010-2202025-00

CC 506





10

CROCIERA CARDANICA
крестовина - u-joint

Марка	Модель	Характеристики	Номер в каталоге автопроизводителя	Артикул Trialli
-------	--------	----------------	------------------------------------	-----------------

LADA

2101-2107

D 23.84 mm
H 61.24 mm

LADA:

21050-2202025-00

CC 146

LADA



2121
2123
2131
2120D 28 mm
H 71 mm

LADA:

21210-2202025-00

CC 394



Марка	Модель	Характеристики	Номер в каталоге автопроизводителя		Артикул Trialli
LADA	2121 2123	D 27 mm H 74.61 mm	LADA:	21230-2202025-00	CC 395
FORD	Transit VI (00-)		FORD:	1 798 134	
LAND ROVER	Defender (83-)				
NISSAN	Pathfinder R51 (05-) Navara (05-)		NISSAN:	37125-2X801	
IZH	2140 412 2715	D 28 mm H ₁ 52.2 mm H 83 mm	IZH:	412-2201025	CC 512
GREAT WALL	Deer (05-) Safe (04-)		GREAT WALL:	2203103-D07	



12

CROCIERA CARDANICA
крестовина - u-joint

Марка	Модель	Характеристики	Номер в каталоге автопроизводителя	Артикул Trialli
GAZ	2217 3110 3302 24 3111	D 30 mm H ₁ 55 mm H 88 mm	GAZ: 3102-2201026 3102-2205025	CC 561
UAZ	2206 Hunter (03-) 469 Patriot (97-)		UAZ: 469-2201025	
MTZ	82			

GAZ
A21R23
A21R22
Gazelle-Business
Gazelle-Next (13-)

D 29.98 mm
H 92.1 mm

GAZ:
A21R23.2200010
A21R33.2200010

CC 562



Марка	Модель	Характеристики	Номер в каталоге автопроизводителя		Артикул Trialli
SUZUKI	Jimny II (98-) Jimny III (03-) Grand Vitara (98-) Vitara (96-) Samurai (98-)	D 25 mm H 63.8 mm	SUZUKI:	27200-83812	CC 401 
MITSUBISHI	Outlander I (03-) L200 (96-) Pajero II (90-) Pajero III (00-)		MITSUBISHI:	MR196837	
NISSAN	Terrano (93-)				
MITSUBISHI	Pajero II (90-) Pajero Sport (08-) L200 (96-) Pajero III (00-)	D 30 mm H ₁ 55 mm H 84.8 mm	MITSUBISHI:	MR232151	CC 402 
					
					



14

CROCIERA CARDANICA
крестовина - u-joint

Марка	Модель	Характеристики	Номер в каталоге автопроизводителя	Артикул Trialli
-------	--------	----------------	------------------------------------	-----------------

MITSUBISHIL200 (96-)
Pajero II (90-)
L200 (06-)
Pajero Sport (08-)
Pajero III (00-)
Pajero IV (06-)D 25 mm
H 76.8 mm**MITSUBISHI:**

MR196838

CC 403**MITSUBISHI**L200 (96-)
L200 (06-)
Pajero II (90-)
Pajero Sport (08-)D 30 mm
H₁ 71 mm
H 101 mm**MITSUBISHI:**

MR377128

CC 404



Марка	Модель	Характеристики	Номер в каталоге автопроизводителя	Артикул Trialli
-------	--------	----------------	------------------------------------	-----------------

HONDA

HR-V I (98-)
CR-V I (95-)

D 20.06 mm
H 52.8 mm

HONDA:

40100-S10-A01

CC 410



NISSAN

Pathfinder WD21 (85-)
NP300 (08-)

D 27 mm
H₁ 46 mm
H 72 mm

NISSAN:

37125-01G25

CC 420





16

CROCIERA CARDANICA
крестовина - u-joint

Марка	Модель	Характеристики	Номер в каталоге автопроизводителя	Артикул Trialli
-------	--------	----------------	------------------------------------	-----------------

NISSANNP300 (08-)
Patrol Y61 (97-)D 28 mm
H₁ 53.1 mm
H 79.5 mm**NISSAN:**

37125-VB925

CC 421**NISSAN**Patrol Y60 (87-)
Patrol Y61 (97-)D 32 mm
H₁ 65.1 mm
H 99.9 mm**NISSAN:**

37125-01J25

CC 426



Марка	Модель	Характеристики	Номер в каталоге автопроизводителя	Артикул Trialli
-------	--------	----------------	------------------------------------	-----------------

KIA	Sorento (02-) Sorento (06-)	D 27 mm H ₁ 46 mm H 72 mm	HYUNDAI: 49598-3E100	CC 440
------------	--------------------------------	--	-----------------------------	---------------



CHEVROLET	Captiva (06-)	D 24.06 mm H 74.4 mm	GM: 20781756	CC 441
------------------	---------------	-------------------------	---------------------	---------------







OPEL	Antara (06-)		OPEL: 04 46 073	
HYUNDAI	Santa Fe II (06-)			
MERCEDES-BENZ	Vito (W639) (03-)			
DAEWOO	Winstorm (07-)			





18

CROCIERA CARDANICA
крестовина - u-joint

Марка	Модель	Характеристики	Номер в каталоге автопроизводителя	Артикул Trialli
BMW	5 E34 (88-)	D 24.06 mm H 62 mm	BMW: 26 11 7 518 304	CC 470 
NISSAN	X-Trail T31 (07-) Qashqai J10 (06-)	 	NISSAN: 37126-11975	
BMW	5 F07 (09-) 5 F10/F18/F11 (10-) 6 F06/F13 (12-) 7 F01/F02/F01N/ F02N/F03/F03N/F04 (08-)	D 24 mm H 56 mm	BMW: 26 20 8 605 866	CC 471 

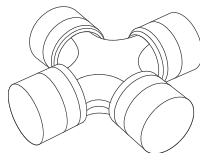



Марка	Модель	Характеристики	Номер в каталоге автопроизводителя	Артикул Trialli
JEEP	Cherokee XJ (84-) Wrangler TJ (96-) Grand Cherokee (92-) Wrangler YJ (86-)	D 27 mm H ₁ 52.6 mm H 81.75 mm	CHRYSLER: J812 6637	CC 490







CHEVROLET	TrailBlazer (01-) Tahoe II (99-)	D 28.57 mm H ₁ 61.9 mm H 92.5 mm	GM: 89029290	CC 491
-----------	-------------------------------------	---	---------------------	---------------





20

CROCIERA CARDANICA
крестовина - u-joint

Марка	Модель	Характеристики	Номер в каталоге автопроизводителя	Артикул Trialli
CHERY	Tiggo (T11) (06-)	D 29 mm H 77 mm	CHERY: T11-2202020CB	CC 508 
GREAT WALL	Hover H5 (11-)		GREAT WALL: 2201116-D01	
UAZ	3909		UAZ: W33036-2201010-17 33036-2201010-17	
FORD	Transit VII (06-)	D 30.18 mm H 92 mm	FORD: 1835511	CC 515 
FOTON	Sauvana (15-)		FOTON: U1220400002A0	



Марка	Модель	Характеристики	Номер в каталоге автопроизводителя		Артикул Trialli
FORD	Transit VI (00-)	D 30 mm H 81.7 mm	FORD:	1C15 4635 CA	CC 516
NISSAN	Cabstar (07-)		NISSAN:	37125-MB925	
HYUNDAI	Santa Fe (00-) Starex (H-1) (96-) Porter (H-100/TagAZ) (96-) Porter IV (H-100) (04-)	D 27 mm H 80 mm	HYUNDAI:	49140-4A000	CC 524





22

CROCIERA CARDANICA
крестовина - u-joint

Марка	Модель	Характеристики	Номер в каталоге автопроизводителя	Артикул Trialli
KIA	Sportage II (04-) Sportage I (93-) Sorento (02-)	D 26.5 mm H ₁ 48 mm H 71 mm	KIA: 0N010-25-060A	CC 526 
				
HYUNDAI	Tucson I (04-)		FORD: 3 636 482	
FORD	Ranger (06-)			
KIA	Sportage III (10-) Sorento II (09-)	D 24.06 mm H 64 mm	HYUNDAI: 49300-2S000	CC 529 
HYUNDAI	iX35 (10-) Tucson II (11-)			
HONDA	Pilot (08-)			
MAZDA	CX-9 I (07-)			



Марка	Модель	Характеристики	Номер в каталоге автопроизводителя	Артикул Trialli
-------	--------	----------------	------------------------------------	-----------------

RENAULT

Duster (10-)

D 19.05 mm
H 55.5 mm

RENAULT:

320003602R

CC 538



NISSAN

Terrano (14-)



KIA

Sorento (02-)

D 32 mm
H₁ 57 mm
H 92 mm

KIA:

49598-3E300





CC 542





24

CROCIERA CARDANICA
крестовина - u-joint

Марка	Модель	Характеристики	Номер в каталоге автопроизводителя	Артикул Trialli
SSANGYONG	Kyron (05-) Actyon (05-) Korando (95-) Actyon Sport (05-) Musso (93-) Rexton (02-)	D 27 mm H 82 mm	SSANGYONG: 3311501000	CC 549 
GREAT WALL	Hover H5 (11-)	 	GREAT WALL: 2201116-F00	
NISSAN	Pathfinder R51 (05-) Navara (05-)		NISSAN: 37125-EB30A	
MAZDA	BT-50 I (06-)			
JEEP	Wrangler JK (07-)			
TOYOTA	RAV 4 (00-)	D 22.06 mm H 57.5 mm	TOYOTA: 04371-13020	CC 550 
SUBARU	Forester SF (97-)	 		
LEXUS	RX II (03-)			



Марка	Модель	Характеристики	Номер в каталоге автопроизводителя	Артикул Trialli
-------	--------	----------------	------------------------------------	-----------------

TOYOTA

Land Cruiser Prado 120 (02-)
Land Cruiser Prado 150 (09-)
FJ Cruiser (07-)
Land Cruiser 100 (98-)
Land Cruiser 200 (07-)
Tundra (00-)

D 29.01 mm
H₁ 47.3 mm
H 77.2 mm

TOYOTA:

04371-60070

CC 551



TOYOTA

Land Cruiser 200 (07-)
Land Cruiser 100 (98-)
Land Cruiser 80 (89-)

D 32.01 mm
H₁ 60 mm
H 92 mm

TOYOTA:

04371-36050

CC 552





26

CROCIERA CARDANICA
крестовина - u-joint

Марка	Модель	Характеристики	Номер в каталоге автопроизводителя	Артикул Trialli
TOYOTA	Hilux (05-)	D 27 mm H 92.1 mm	TOYOTA: 04371-0K080	CC 553 
NISSAN	Pathfinder R51 (05-) Navara (05-)	 		
MAZDA	BT-50 I (06-)			
JEEP	Grand Cherokee (99-)			
MERCEDES-BENZ	Sprinter (95-)			

TOYOTA	RAV4 III A30 (06-)	D 20.92 mm H 52.5 mm	TOYOTA: 3710042080	CC 555 
--------	--------------------	-------------------------	--------------------	--

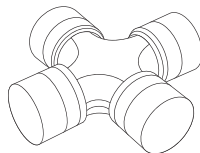



Марка	Модель	Характеристики	Номер в каталоге автопроизводителя	Артикул Trialli
-------	--------	----------------	------------------------------------	-----------------

IVECO

Daily III (99-)
Daily V (11-)

D 30.24 mm
H 106.3 mm

IVECO:

93158199

CC 723



MERCEDES-BENZ

Vito (W638) (96-)
Sprinter (06-)

D 24.09 mm
H 88.1 mm

MERCEDES-BENZ: A9064100616

CC 747





28

CROCIERA CARDANICA
крестовина - u-joint

Марка	Модель	Характеристики	Номер в каталоге автопроизводителя	Артикул Trialli
-------	--------	----------------	------------------------------------	-----------------

MERCEDES-BENZ Vito (W638) (96-)
Sprinter (06-)D 31.08 mm
H 88.5 mm**MERCEDES-BENZ:** A4604101904**CC 748****MERCEDES-BENZ** Vito (W638) (96-)
Sprinter (06-)D 27.08 mm
H 88 mm**MERCEDES-BENZ:** A9064103401**CC 749****KIA**

Sorento (06-)





Марка	Модель	Характеристики	Номер в каталоге автопроизводителя	Артикул Trialli
-------	--------	----------------	------------------------------------	-----------------

ISUZU

ELF 7.5 (03-) (NLR75)
ELF 9.5 (03-) (NQR90)

D 35 mm
H 103.9 mm

ISUZU:

1-37300-058-0
1-37300-089-0

CC 760



ISUZU

ELF 3.5 (03-) (NLR85)

D 33 mm
H 93 mm

ISUZU:

8-97080505-0
8-98033605-0

CC 761





30

CROCIERA CARDANICA
крестовина - u-joint

Марка	Модель	Характеристики	Номер в каталоге автопроизводителя	Артикул Trialli
-------	--------	----------------	------------------------------------	-----------------

MITSUBISHI
FUSO

Canter TD (02-)
Canter TD (10-)

D 31.75 mm
H 102 mm

MITSUBISHI: MK996631

CC 770



HYUNDAI

HD120 (04-)

D 46 mm
H 142 mm

HYUNDAI: 49140-73000

CC 771





Марка	Модель	Характеристики	Номер в каталоге автопроизводителя	Артикул Trialli
-------	--------	----------------	------------------------------------	-----------------

HYUNDAI

HD 45/65/72/78 (04-)

D 34.92 mm
H₁ 72 mm
H 106.5 mm

HYUNDAI:

49150-45220

CC 772



GAZ

53
66
3307
3308

D 35 mm
H 98 mm

GAZ:

53-2201800

CC 652



PAZ

3205, 32053, 32054
(дв. ЗМЗ 5234.10)

Ural





4320
4420





32

CROCIERA CARDANICA
крестовина - u-joint

Марка	Модель	Характеристики	Номер в каталоге автопроизводителя	Артикул Trialli
GAZ	53 66 3307 3308	D 35 mm H 98 mm	GAZ: 53A-2201025 33081-2202010	CC 653 
PAZ	3205, 32053, 32054 (дв. 3М3 5234.10)			
URAL	4320 4420			
GAZ	53 66 3307 3308	D 35 mm H 98 mm	GAZ: 53A-2201025-01	CC 654 
PAZ	3205, 32053, 32054 (дв. 3М3 5234.10)			
Ural	4320 4420			



Марка	Модель	Характеристики	Номер в каталоге автопроизводителя	Артикул Trialli
-------	--------	----------------	------------------------------------	-----------------

GAZ

GAZon-Next (14-)
PAZ Vector Next

D 34.95 mm
H 106.3 mm

GAZ:

4530307
C41R13-4530307

CC 655



GAZ

GAZon-Next (14-)
PAZ Vector Next

D 35.06 mm
H 106,5 mm

GAZ:

UJ.68730.10.02
C41RB3.2200010-01

CC 656



**CROCIERA CARDANICA**
крестовина - u-joint

Марка	Модель	Характеристики	Номер в каталоге автопроизводителя		Артикул Trialli
MAZ	5336 5432 5516 6303 6422	D 62 mm H 173 mm	MAZ:	540-2201025	CC 612 
BELAZ	7522 7540				
KAMAZ	4326 5315	D 50 mm H 155 mm	KAMAZ:	4310-2205025	CC 613 
MAZ	103 104 105 107 152 5337 54323 5516 5551 6422				
KRAZ	250				



Марка	Модель	Характеристики	Номер в каталоге автопроизводителя	Артикул Trialli	
KAMAZ	4308		D 50 mm H 135 mm	KAMAZ: 5320-2205025 5320-2205026 6520-2201025	CC 614 
	4311				
	4326				
	5320				
	5321				
	53212				
	5410				
	54112				
	5511				
	55102				
	55112				
55115					
ZIL	131 133				
URAL	4320 5557				
KAMAZ	65115		D 50 mm H 155 mm	KAMAZ: 53205-2205025	CC 617 
MAZ	5336 5432 6303 6422	 			



36

CROCIERA CARDANICA
крестовина - u-joint

Марка	Модель	Характеристики	Номер в каталоге автопроизводителя	Артикул Trialli
-------	--------	----------------	------------------------------------	-----------------

KAMAZ

6522

D 52 mm
H 154 mm

KAMAZ:

340-002-7205
41-015-7205

CC 619











Марка	Модель	Характеристики	Номер в каталоге автопроизводителя		Артикул Trialli
KAMAZ	4308	D 39 mm H 118 mm	KAMAZ:	5320-2201025	CC 620 
	4311				
	4326				
	5320				
	5321				
	53212				
	5410				
	54112				
	55102				
	5511				
	55112				
55115					
PAZ	3204		ZIL:	130-2201025	
URAL	4320				
	4420				
	5323				
	5557				
ZIL	130				
	133				
	4331				
	4333				
	4421				
4945					
BELAZ	7512				
	7549				



**CROCIERA CARDANICA**
крестовина - u-joint

Марка	Моделъ	Характеристики	Номер в каталоге автопроизводителя	Артикул Trialli
KAMAZ	5320	D 39 mm H 118 mm	KAMAZ: 5320-2201025-01 5320-2201025-10	CC 621 
URAL	4320 5557	 	GAZ: 4301-2201025-A	
GAZ	33104 33106 4301		FOTON: HWJ3-382-00	
FOTON	Aumark BJ10 (05-)			
MAN	F / M / L 2000 F / M / G 90 F 7/8/9	D 52 mm H 147.2 mm	MAN: 81.39126.6020 81.39126.6030	CC 702 
MAN BUS/ NEOPLAN	RH Lion's Coach/Regio/Star Cityliner Jetliner Tourliner Trendliner	 		



Марка	Модель	Характеристики	Номер в каталоге автопроизводителя		Артикул Trialli
MAN	F 7/8 M/F 90 F 2000 TGM TGA/TGS/TGX	D 57 mm H 152 mm	MAN:	81.39108.6048	CC 705
DAF	F 2800/2900/3200 F 3300/3600 N 2800 F 75/85/95 85 CF 95 XF CF 75/85 XF 95		DAF:	1235571	
RENAULT TRUCKS	D/C/K/T				
VOLVO	FH/FM/FMX/NH 9/10/11/12/13/16 F/FL 6 F/FE/FL/FM 7				





40

CROCIERA CARDANICA

крестовина - u-joint

Марка	Модель	Характеристики	Номер в каталоге автопроизводителя	Артикул Trialli
KAMAZ	6520	D 57 mm	KAMAZ: 6520-2205025 45104-2205100-90 45104-2205101-90	CC 705 
	6460	H 152 mm		
	5460			
MERCEDES-BENZ	L-Series: BM 343/346/352 O 300-/O 400-Series / Setra S 200-/ 300-Series: BM 345/397 Atego/Econic: Atego 1/2 950/952/953/954, 970/976 Econic 1 957 Actros/Antos/Arocs/Axor: Actros 1 950/954; Actros 2/3 930/934; Axor 375/950/952/953, 954 SK/MK/NG-Series: BM 387/389, 391/393/395, 620/621/622/623, 624/625, 645/646/647/648, 649, 652/653/654/655, 656/657/658/659		MERCEDES-BENZ: 3874100031	

VOLVO BUS

B 9 R
B 12 B /M
B 13 R

MAN BUS /
NEOPLAN

RH
Lion's Coach/Regio/Star Cityliner
Skyliner, Starliner, Tourliner,
Trendliner



CROCIERA CARDANICA
крестовина - u-joint



41

Марка	Модель	Характеристики	Номер в каталоге автопроизводителя	Артикул Trialli
-------	--------	----------------	------------------------------------	-----------------

KAMAZ

5490

D 59 mm
H 167,5 mm

KAMAZ:

UJ.68760.04.02

CC 622



KAMAZ

5490

D 65 mm
H 172 mm

KAMAZ:

UJ.68765.03.02

CC 732



VOLVO

5490
FH/FM (05-)

VOLVO:

20366348





42

CROCIERA CARDANICA
крестовина - u-joint

Марка	Модель	Характеристики	Номер в каталоге автопроизводителя		Артикул Trialli
MAN	F 7/8 F 90 L 2000	D 57 mm H 144 mm	MAN:	81.39126.6017	CC 706 
VOLVO	F 10 1976-1983 F 12 1976-1983 N 10/12 GWB		VOLVO:	232540	
RENAULT TRUCKS	CBH/CLM G/R Major		KAMAZ:	6520-2205025-10	
DAF	F 2800/2900/3200 F 3300/3600 N 2800 F 95				
IVECO	PA/P TurboTech EuroTech EuroStar				
VOLVO BUS	B 10 M (BR)				
KAMAZ	6520 6460 5460				





Марка	Модель	Характеристики	Номер в каталоге автопроизводителя		Артикул Trialli
MAN	F 7/8 M/F 90	D 52 mm H 133 mm	MAN:	81.39126.6021	CC 707 
DAF	F 2800/2900/3200 F 3300/3600 N 2800 F 75/85/95		DAF:	264 354	
RENAULT TRUCKS	CBH/CLM G/R Major		RENAULT:	00 03 397 100	
MERCEDES-BENZ	O 300-/O 400-Series / Setra S 200- /S 300-Series: BM 357/364/382/397, 664 L-Series: BM 336/346/349		GOLDEN DRAGON:	99114310125	
MAN BUS / NEOPLAN	SL/SG/Sb/SD NL/NG EL/bL				
YUTONG	ZK6129				
GOLDEN DRAGON	XML6102				
HIGER	KLQ6109Q 6129Q KLQ6118 KLQ6108 6118				







**CROCIERA CARDANICA**
крестовина - u-joint

Марка	Модель	Характеристики	Номер в каталоге автопроизводителя	Артикул Trialli
SCANIA	L-/P-/G-/R-/S-Series P 400/500/520, P 604/644 P-/G-/R-/T-Series P 500/510/520 Scania 2-/3-Series P-PF 50, P 500/510, P 520/540, T-TA 71/81 4-Series P 500/510, P 520/540	D 57 mm H 164 mm	SCANIA: 1 797 425 1879540	CC 710 
SCANIA BUS	F-/K-/N-Series P 500/510			
SCANIA	L-/P-/G-/R-/S-Series P 604/614/644 P-/G-/R-/T-Series P 600/602 Scania 2-/3-Series P-PF 60, P 600/610 4-Series P 300/310, P 400/410, P 420/440, P 500/510, P 520/540, P 610	D 65 mm H 190 mm	SCANIA: 1879541	CC 711 





Марка	Модель	Характеристики	Номер в каталоге автопроизводителя	Артикул Trialli
DAF	F 2800/2900/3200 F 3300/3600 N 2800 F 65/75/85 65/75 CF CF 75	D 47.6 mm H 135.2 mm	DAF: 1 250 299	CC 722
RENAULT TRUCKS	Midlum Premium /TR/PR Kerax AE Magnum Magnum E-Tech	 	RENAULT: 50 01 836 379	
IVECO	Eurocargo EuroTech		IVECO: 93160516	
KAMAZ	6520		KAMAZ: 6520-2201025-10	
MAN	F 2000		D 48 mm H 135.4 mm	MAN: 81.39126.6033
MAN BUS / NEOPLAN	SL NL Lion's City/Classic	 	IVECO: 42534500	
IVECO	P/PA/MK Eurocargo TurboTech EuroTech EuroStar EuroTrakker		KAMAZ: 45104-2201100-90	
KAMAZ	6520			



46

CROCIERA CARDANICA
крестовина - u-joint

Марка	Модель	Характеристики	Номер в каталоге автопроизводителя	Артикул Trialli
VOLVO	F/FL 6, F/FE/FL/FM 7 FL 6, -- chassis B264999, K 45, FL 7, NK 431 THK 91, NK 435 THK 91, NK 451 THK 91, NK 455 THK 91 FH/FM/FMX/NH 9/10/11/12/13/16 K 45 F/FL/N/NL 10/12/16 F 10/12/16, FL 10/12, N 10/12 NK 441/444, NK 451/455, NK-K45, NK-K46	D 50 mm H 152.6 mm	VOLVO: 1651032	CC 730
VOLVO BUS	B 10 B /BLE B 10 M B 12			
VOLVO	FH 12 1993-1998 FM 10 FM 12 1998-2001 NH 12 /BR	D 55 mm H 164.4 mm	VOLVO: 8127230	CC 751
RENAULT TRUCKS	Premium /TR/PR Kerax AE AE Magnum		RENAULT: 5001836375	



GMB	Trialli	Страница
210-0260	CC 490	19
G5-155X	CC 772	31
GU-1670	CC 470	18
GU-2050	CC 723	27
GU-7050	CC 508	20
GUIS-62	CC 760	29
GUK-12	CC 524	21
GUK-13	CC 441	17
GUK-14	CC 440	17
GUM-73	CC 549	24
GUM-75	CC 770	30

GMB	Trialli	Страница
GUM-80	CC 771	30
GUM-81	CC 401	13
GUM-91	CC 403	14
GUM-93	CC 402	13
GUM-99	CC 404	14
GUMZ-9	CC 526	22
GUN-29	CC 421	16
GUN-30	CC 515	20
GUN-35	CC 426	16
GUN-45	CC 410	15
GUN-46	CC 420	15

GMB	Trialli	Страница
GUN-50	CC 395	11
GUT-20	CC 552	25
GUT-23	CC 551	25
GUT-24	CC 550	24
GUT-29	CC 553	26
ST1539	CC 912	6
ST-1540	CC 901	5
ST1639	CC 905	5
ST1640	CC 910	6
ST1948	CC 914	9



48

CROCIERA CARDANICA
крестовина - u-joint

FEBI	Trialli	Страница
09921	CC 710	44
11546	CC 705	39, 40
11547	CC 706	42
11548	CC 702	38
11686	CC 730	46
14510	CC 707	43
14512	CC 441	17
23836	CC 722	45
38034	CC 751	46
38414	CC 748	28

FEBI	Trialli	Страница
38416	CC 747	27
38417	CC 749	28
47427	CC 761	29
47440	CC 770	30

Diesel Technic	Trialli	Страница
1.15020	CC 710	44
1.15200	CC 711	44
2.34001	CC 730	46
2.34003	CC 706	42
2.34012	CC 732	41
3.59004	CC 702	38
4.60111	CC 707	43
4.60390	CC 705	39, 40
5.14008	CC 722	45
6.59002	CC 751	46
7.20011	CC 724	45

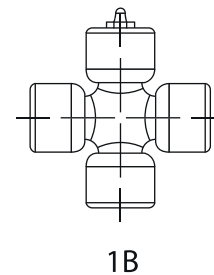
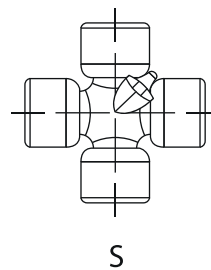
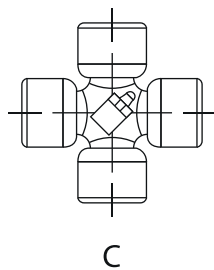
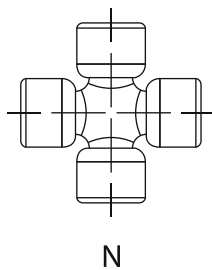
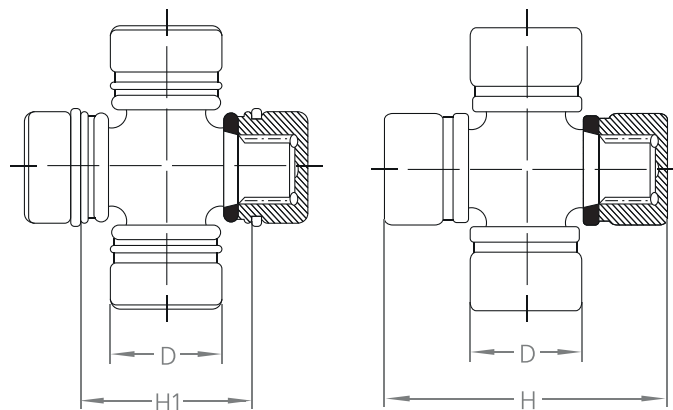



50

CROCIERA CARDANICA
крестовина - u-joint

Артикул	D, мм	H ₁ , мм	H, мм	Тавотница	Страница
CC 901	15		40	N	5
CC 912	15,07		39	N	6
CC 905	16		39	N	5
CC 910	16		40	N	6
CC 902	19		44,6	S	7
CC 908	19		56,3	N	8
CC 538	19,05		55,5	N	23
CC 914	19,08		48	C	9
CC 410	20,06		52,8	N	15
CC 555	20,92		52,5	N	26
CC 550	22,06		57,5	N	24
CC 146	23,84		61,24	1B	10
CC 506	23,84		61,24	1B	9
CC 471	24		56	N	18
CC 441	24,06		74,4	N	17
CC 470	24,06		62	N	18
CC 529	24,06		64	N	22
CC 747	24,09		88,1	N	27
CC 401	25		63,8	1B	13
CC 403	25		76,8	S	14



Артикул	D, мм	H ₁ , мм	H, мм	Тавотница	Страница
CC 526	26,5	48	71	1B	22
CC 395	27		74,61	S	11
CC 420	27	46	72	1B	15
CC 490	27	52,6	81,75	S	19
CC 524	27		80	S	21
CC 549	27		82	S	24
CC 553	27		92,1	N	26
CC 749	27,08		88	N	28
CC 394	28		71	1B	10
CC 421	28	53,1	79,5	S	16
CC 440	28	48,2	77,2	C	17
CC 512	28	52,2	83	1B	11
CC 906	28	37	67,8	N	7
CC 907	28	42,5	73	N	8
CC 491	28,57	61,9	92,5	S	19
CC 508	29		77	S	20
CC 551	29,01	47,3	77,2	C	25
CC 562	29,98		92,1	N	12
CC 402	30	55	84,8	C	13
CC 404	30	71	101	C	14



Артикул	D, мм	H ₁ , мм	H, мм	Тавотница	Страница
CC 516	30		81,7	C	21
CC 561	30	55	88	1B	12
CC 515	30,18		92	N	20
CC 723	30,24		106,3	S	27
CC 748	31,08		88,5	1B	28
CC 770	31,75		102	S	30
CC 426	32	65,1	99,9	C	16
CC 542	32	57	92	S	23
CC 552	32,01	60	92	S	25
CC 761	33		93	C	29
CC 772	34,92	72	106,5	S	31
CC 655	34,95		106,3	C	33
CC 653	35		98	C	32
CC 652	35		98	C	31
CC 654	35		98	C	32
CC 760	35		103,9	S	29
CC 656	35,05		16,5	C	33
CC 620	39		118	S	37
CC 621	39		118	C	38
CC 771	46		142	C	30



Артикул	D, мм	H ₁ , мм	H, мм	Тавотница	Страница
CC 722	47,6		135,2	C	45
CC 724	48		135,4	C	45
CC 613	50		155	C	34
CC 614	50		135	C	35
CC 617	50		155	C	35
CC 730	50		152,6	C	46
CC 619	52		154	C	36
CC 702	52		147,2	C	38
CC 707	52		133	C	43
CC 751	55		164,4	C	46
CC 705	57		152	C	39, 40
CC 706	57		144	C	42
CC 710	57		164	C	44
CC 622	59		167,5	C	41
CC 612	62		173	C	34
CC 732	65		173	C	41
CC 711	65		190	C	44

WWW.TRIALLI.RU



Большой запас по мощности передаваемого момента

Мы рассчитали все возможные пиковые нагрузки и добавили еще прочности. Только так получается действительно надежная деталь.



Продуманная комплектация

Наличие уплотнителей и крепежных деталей позволяет гарантировать высокую надежность и длительную работу отремонтированных узлов.



4 – Прецизионный класс точности



Высокая статическая и динамическая грузоподъемность

Подшипники TRIALLI обладают высокой статической и динамической грузоподъемностью.